

## JACK

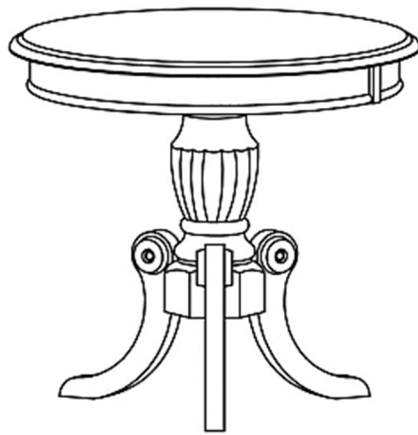

1 PC



1 PC



1 PC

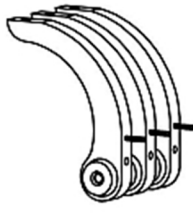

3PCS

STEP 1

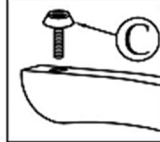

STEP 2

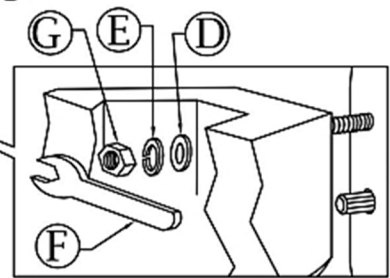
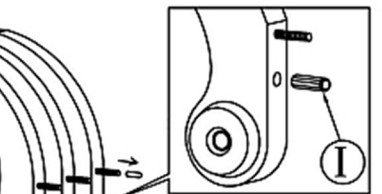
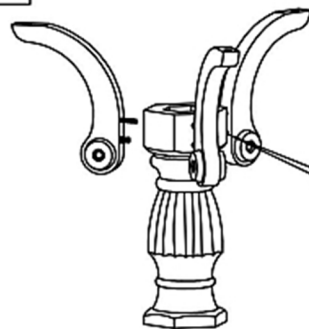

STEP 3

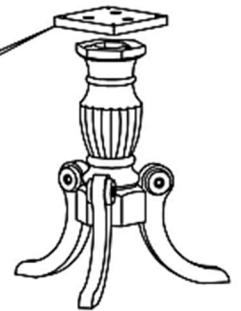
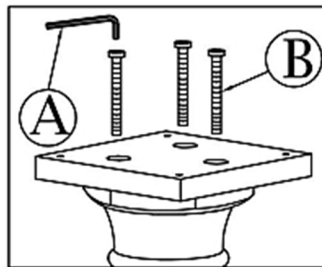

STEP 4

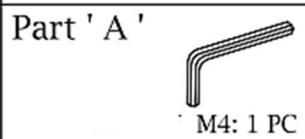
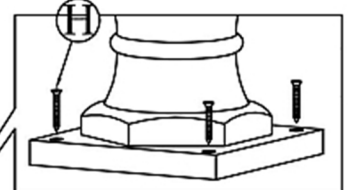
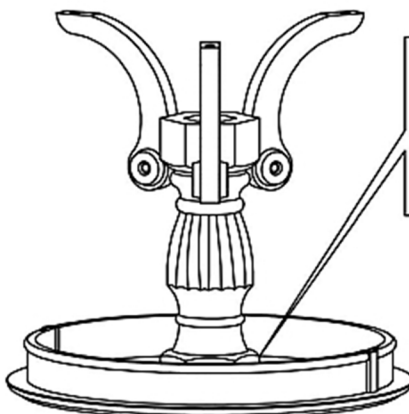

M4: 1 PC

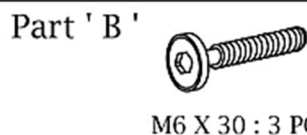

M6 X 30 : 3 PC

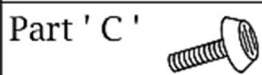

M6 X 16 : 3 PCS



5/16" : 3 PCS

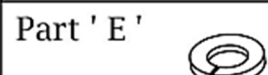

5/16" : 3 PCS

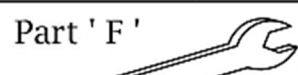

12.8MM : 1 PC

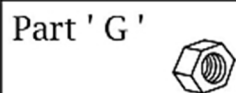

5/16"X12.7 : 3 PCS

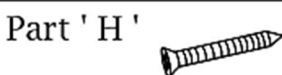

M4 X 32  
4 PCS

Part ' I '



M10 X 30: 3 PCS